

AKADÉMIAI KIADÓ



International Review of  
Applied Sciences and  
Engineering

13 (2022) 2, 124–132

DOI:

10.1556/1848.2021.00322

© 2021 The Author(s)

ORIGINAL RESEARCH  
PAPER



# Estimation of coefficient of performance of thermoelectric cooler using a 30 W single-stage type

Rotimi Adedayo Ibikunle<sup>1\*</sup> , Mutalubi Aremu Akintunde<sup>2</sup>,  
Isaac Femi Titiladunayo<sup>2</sup> and Adekunle Akanni Adeleke<sup>1</sup>

<sup>1</sup> Department of Mechanical Engineering, Landmark University, Omu-Aran, Kwara State, Nigeria

<sup>2</sup> Department of Mechanical Engineering, Federal University of Technology, Akure, Ondo State, Nigeria

Received: June 9, 2021 • Accepted: August 2, 2021

Published online: September 23, 2021

## ABSTRACT

In this study, a single stage thermoelectric cooler (TER, of size:  $21 \times 14.2 \times 13.5$  cm) with thermoelectric module (TEM, of type *inbc1-127.05* with size  $40 \times 40 \times 4.0$  mm) and applied electrical power of 30 W and current of 2.5 A, was adopted to estimate the coefficient of performance (COP) of thermoelectric refrigerator (TER). The TER uses a fan to cool the heat exchange region of the TEM. The temperature of the fruit/vegetable samples used in this study was taken before and after cooling for a specific period. The temperatures at both the hot and cold sides of the TEM were also taken at every specific cooling period. The experimented TER can cool vegetable/fruit from about 27 to 5°C within 3 h. The aim of this study is to determine the COP of TER to ascertain the possible applications. The temperature gradient at the heat exchange section of TEM was used to estimate the average theoretical COP to be 0.99, the heat extracted from the cooling chamber and the power supplied was used to estimate the average practical cooling COP to be 0.52; which is within 0.4–0.7 standard COP for a single stage type of TER.

## KEYWORDS

single stage TER, thermoelectric module, temperature gradient, theoretical coefficient of performance, practical coefficient of performance

## 1. INTRODUCTION

Refrigeration can be defined as the processes involved in reducing and maintaining the temperature of a space or material below that of its surrounding. This can be achieved by extraction of heat from the body to be cooled or refrigerated and move the same to another body of higher temperature. The refrigeration systems available include vapor compression system, vapor absorption system and thermoelectric system. The demand for refrigerating systems to meet global requirements for medical services, vaccine and food preservation and cooling of electronic appliances is on the high side lately. The conventional refrigeration systems that are produced to meet the demand, operate with the aid of either chlorofluorocarbons (CFCs) or other chemical substances, that may be hazardous to our environment. Thermoelectric devices neither utilize CFCs in their operation, nor release greenhouse gases (GHGs) such as carbon dioxide CO<sub>2</sub>, that can contribute to ozone layer depletion [1]. Moreover, thermoelectric refrigerators or coolers are very quiet in operation because they have no moving parts; the power required to operate them is convenient [1]. Thermoelectric refrigerator (TER), is a new and a sustainable alternative, because it can operate using electricity generated from waste, which will perform an important function in combatting the challenges facing energy today [2]. Consequently, TER are significantly needed [3], most

\*Corresponding author.

E-mail: [ibikunle.rotimi@lmu.edu.ng](mailto:ibikunle.rotimi@lmu.edu.ng)

especially in the developing nations where refrigerators with extended life and little maintenance are required [3, 4].

Thermoelectric refrigerator (TER), is a system used in many cooling processes such as applied in medical instruments, machines and electronic appliances. The cooling unit used is called thermoelectric module (TEM). It consists of cold and hot junctions in series as shown in Fig. 1, developed as alternative ecofriendly device for pumping heat. The thermoelectric module (TEM) is made up of either Lead Telluride or Bismuth Telluride pellets of combination of semiconductor, thermal, and electrical properties; used to convert heat energy recovered from waste into electrical energy [5]. The electrical energy is used for heating and cooling purposes. The operation of TEM is based on thermoelectric effect, which includes Seebeck Effect, Peltier Effect and Thomson Effect. The Peltier Effect is applied in a thermoelectric cooling system whereas, Seebeck Effect is applied in a power generator [6]. Coefficient of performance (COP) in refrigeration, is the ratio of the heat extracted (i.e. output) from the refrigerated body to the quantity of (input) energy needed to produce the refrigerating effect; this has correlation with the efficiency of a machine. COP in thermoelectric refrigerator can be defined as the quantity of heat pumped by TEM, that can be obtained from each unit of electrical power supplied. In this paper, the procedure for establishing the COP of thermoelectric refrigerator or cooler (TER or TEC) is provided. This will enable us to ascertain the appropriate COP required for a cooling process of a specified temperature.

### 1.1. TER principle of operation

Thermoelectric module (TEM) operates by moving the heat generated at the hot side of the system to the area of relatively cold region. During cooling process, the current from the power supply passes across the n-type semiconductor to the p-type; thereby making the temperature of the cooling interconnecting conductor to reduce and hence, heat from the surroundings is absorbed. Peltier Effect phenomenon involves the absorption of heat energy from one dissimilar metal junction and the release of same to another junction, when there is flow of current into the circuit as presented in Fig. 1. COP maximum depends majorly on the temperature gradient that exists between the hot and cold side. It will

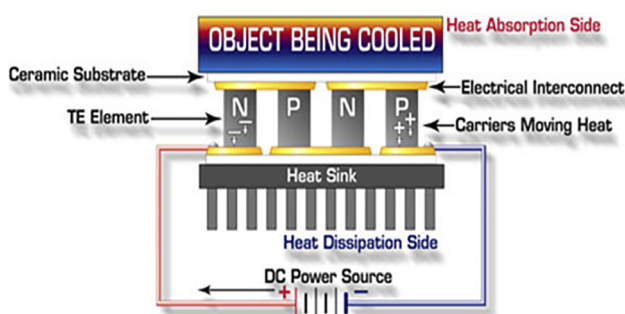

Fig. 1. Schematic representation of thermoelectric refrigerator (TER) Suleiman [7]

shift towards the high current when the temperature gradient increases. Therefore, current should not exceed 70% of the  $I_{max}$  because then COP will be too small, rendering the Peltier element inefficient.

## 2. MATERIALS AND METHOD

### 2.1. Selected fruits and vegetable

Fruits and vegetables that were selected for this investigation include lemon, apple, orange, banana, carrot, tomato, grape; nevertheless, water was included. These experimentation materials were obtained from Ikole market, Ekiti, Nigeria. These materials were chosen because they are better preserved at temperatures not higher than  $7^{\circ}\text{C}$  and not lower than  $4^{\circ}\text{C}$  within a high relative humidity environment.

### 2.2. Single-stage thermoelectric refrigerator

A 30 W single-stage TER with cooling chamber of size  $210 \times 142 \times 135$  mm which is about 4L in capacity and thermoelectric module of type *inbc1-127.05* (with size  $40 \times 40 \times 4.0$  mm), made of bismuth telluride ( $\text{Bi}_2\text{Te}_3$ ) were used in this study. The cabin of the refrigerator is about 20 mm thick, made of hard plastic (Melamine Formaldehyde type). The inner and outer wall is about 5 mm thick discretely, bearing lagging material made of Styrofoam. The plastic wall has thermal conductivity of  $0.1944 \text{ W/m K}$ , and it is lagged with Styrofoam material of  $0.033 \text{ W/m K}$ . The heat exchangers of the refrigerator are finned rectangular Aluminum Alloy (of size  $135 \times 102 \times 15$  mm) for hot side and a square block Aluminum Alloy (of size  $43 \times 43 \times 25$  mm), for cold side. The electrical energy used for pumping heat (instead of compressor) is of 12 V and current of 2.5 A.

### 2.3. Experimentation

The mass of each food item was measured with Labtech BL20001 Electronic Compact Scale shown in Fig. 2 and the temperature of specimens before and after cooling process



Fig. 2. Labtech BL20001 electronic compact scale

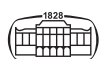

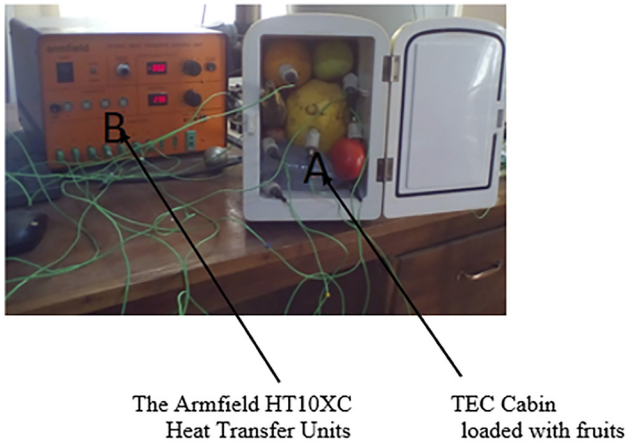

Fig. 3. The Armfield HT10XC Heat Transfer Units and Thermo-electric refrigerator

was measured with Armfield HT10XC Heat Transfer Units; with K-Type Digital Thermocouple sensor.

The mass of each specimen was taken and recorded in grams, the specific heat capacity adopted for each specimen, was obtained from ASHARAE handbook. The temperature

of each specimen before cooling was recorded and the specimens were loaded into the refrigerating cabinet of a single – stage TER, of size 210 mm × 148 mm × 135 mm as presented in Fig. 3. The temperature of the hot side and cold side of the heat exchangers was determined, as well as the ambient temperature of the experimentation environment. Electrical power 30 W (voltage = 12 V, current = 2.5 A) was supplied to the TEM, and the temperature of each specimen loaded into the refrigerator was taken and recorded after cooling for a specific period. The heat ( $Q_h$ ) was transferred from the base of TEM to the tip of finned rectangular aluminum alloy heat exchanger and consequently increased the temperature. The heat generated was dissipated to the surrounding with the aid of fan. The temperature at the fin of hot heat exchanger, increased to 32°C and was rather constant after 3 h of operation, as the temperature ( $T_{hot}$ ) approached 26°C. The cold side temperature ( $T_{cold}$ ) of the block rectangular aluminum alloy heat exchanger, decreased gradually and was rather constant at about 10°C after 3 h of operation. The temperature gradient between the cool and hot sides of the TEM, were recorded for every cooling period. The diagrammatic representation of the experimental set up is presented in Fig. 4.

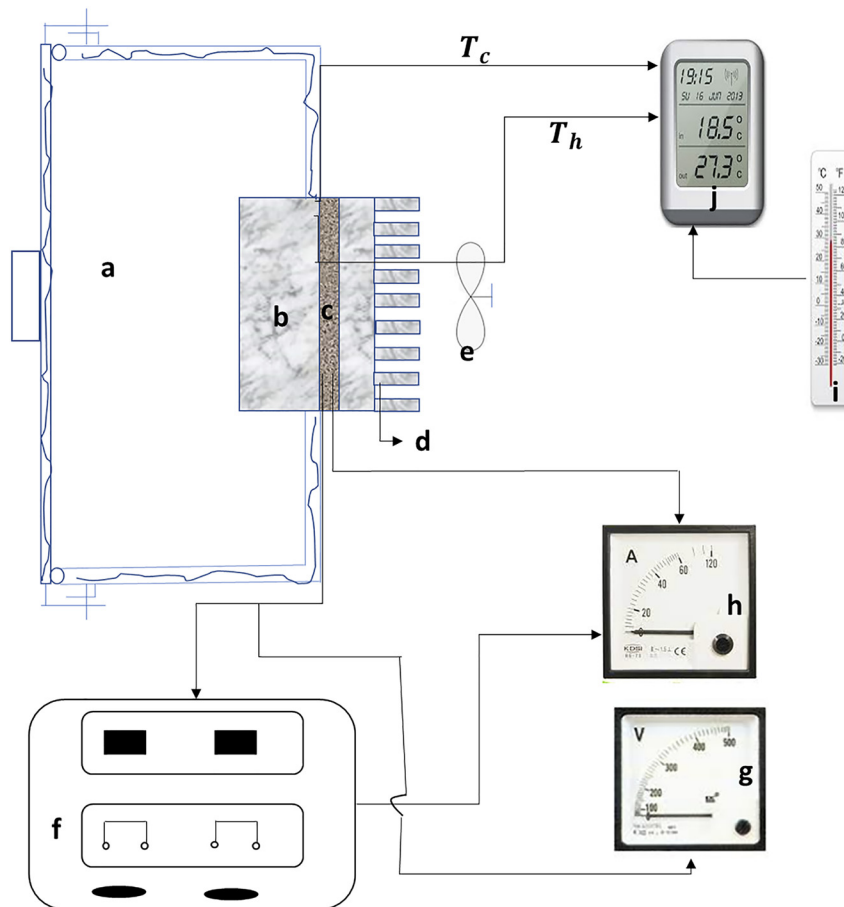

Fig. 4. A schematic representation of the experimental setup for thermal circuit of the thermoelectric cooling system: (a) Thermoelectric Refrigerator, (b) Cold heat exchanger, (c) Thermoelectric module (TEM) - ( $\text{Bi}_2\text{Te}_3$ ), (d) Hot heat sink, (e) Fan, (f) DC power source, (g) Voltmeter, (h) Ammeter, (i) Thermometer, (j) Digital thermometer.  $T_h$  is the temperature of hot side and  $T_c$  is the temperature of the hot side of the heat exchanger

## 2.4. The heat extracted from each item at a corresponding period of cooling

The heat extract from the refrigerated items can be determined according to Ibikunle [1] and Sujith, et al. [8] as presented in Equation (1).

$$Q_{\text{cooling}} = m \times C_p \times (\Delta T) \quad (1)$$

where  $Q_{\text{cooling}}$  is the heat removed from the refrigerated body, while  $m$  is the mass of the specimen,  $C_p$  is the specific heat capacity of the refrigerated body and  $\Delta T$  is the difference between the temperature of specimen before and after refrigeration.

## 2.5. Estimation of the work input required in the cooling process

The work input required in the cooling process is determined by using Equation (2)

$$\text{Work input } (W_{in}) = V * I * T \quad (2)$$

Where  $V$  is the voltage of the power source, 12 V;  $I$  is the current required, which is 2.5 A and  $T$  (s) is the period of refrigeration.

## 2.6. Determination of the theoretical and practical COP

According to Ibikunle [1] and Jugsujinda et al. [9], theoretical COP of thermoelectric refrigerator can be determined using Equation (3)

$$COP_{\text{theoretical}} = \frac{T_{\text{cold}}}{T_{\text{hot}} - T_{\text{cold}}} \quad (3)$$

where  $COP_{\text{theoretical}}$  is the COP of the TER during cooling,  $T_{\text{cold}}$  is the temperature of the cold side of TEM and  $T_{\text{hot}}$  is the temperature of the hot side of the thermoelectric module (TEM). Ibikunle [1] and Sujith et al. [8] suggested that Equations (4) and (5), can be used to determine the practical COP of TER.

$$COP_{\text{ref.}} = \frac{\text{Refrigerating Effect}}{\text{Work input}} \quad (4)$$

$$= \frac{Q_{\text{cooling}}}{W_{in}} \quad (5)$$

where  $COP_{\text{ref.}}$  is the COP of the TER during cooling,  $Q_{\text{cooling}}$  is the total amount of the heat removed from the refrigerated material in Equation (1) and  $W_{in}$  is the work done by the heat pump (TEM) in Equation (2). Ahmed [10]; Manish and Brajesh [11] also suggested that COP of the TER, can be determined by adopting Equation (6).

$$COP_{\text{ref.}} = \frac{Q_1}{W} \quad (6)$$

$$Q_1 = (\alpha_2 - \alpha_1) T_1 I - U(T_1 - T_2) - 1/2 (I^2) R \quad (7)$$

$$W = (\alpha_2 - \alpha_1)(T_1 - T_2)I + (I^2)R \quad (8)$$

The parameters for the semiconductor material, thermoelectric module – Bismuth Telluride ( $Bi_2Te_3$ ) adopted in this investigation was suggested by Manish and Brajesh [11]. The materials: Bismuth (material 1) and Telluride (material 2):

The typical values for  $Bi_2Te_3$  at 21°C

Seebeck coefficient ( $\alpha_2$ ) =  $5 \times 10^{-4}$  V/K

Seebeck coefficient ( $\alpha_1$ ) =  $-7.2 \times 10^{-5}$  V/K

Thermal conductivity ( $k$ ) = 1.5 W/m K

Effective Thermal Conductance (U) = 0.06 W/K

Shape factor ( $F_S$ ) = 1

Emissivity ( $\epsilon$ ) = 1

Resistivity ( $\rho$ ) =  $1 \times 10^{-5}$   $\Omega$ m

Stefan-Boltzmann constant ( $\sigma$ ) =  $5.667 \times 10^{-8}$  W/m<sup>2</sup>K<sup>4</sup>

Convective heat transfer coefficient = 137.5 W/m<sup>2</sup> K

Figure of merit ( $Z$ ) =  $2.67 \times 10^{-3}$  1/K

The Test conditions:

Peltier dimension (40 × 40 × 4.0) mm

Voltage = 12 V

Current = 2.5 A

Resistance = 4.8  $\Omega$

Temperature of hot side ( $T_2$ ) = 32°C

Temperature of cold side ( $T_1$ ) = 10°C

Ambient temperature ( $T_{\text{amb.}}$ ) = 30°C

Therefore,

$$\begin{aligned} Q_1 &= (\alpha_2 - \alpha_1)T_2I - U(T_2 - T_1) - 1/2(I^2)R \\ &= (5 \times 10^{-4} + 7.2 \times 10^{-5})305 \times 2.5 - 0.06(22) - 0.5(2.5^2) \times 4.8 \\ &= 15.883 \text{ W} \end{aligned}$$

$$\begin{aligned} \text{And } W &= (\alpha_2 - \alpha_1)(T_1 - T_2)I + (I^2)R \\ &= (5 \times 10^{-4} + 7.2 \times 10^{-5})(22) \times (2.5) + (2.5^2) \times 4.8 \\ &= 30 \text{ W} \end{aligned}$$

$$\Rightarrow COP = \frac{Q_1}{W} = 0.529$$

## 2.7. Heat load estimation

The heat load can be classified as active and passive, or a combination of both. Active load is that which is dissipated by the device that cools. It is equal to the power input to the device. Passive thermal loads are parasitic in nature, which include the load involved during radiation, convection and conduction modes of heat transfer. Equations 9–13 were adopted for the estimation of the heat load involved in the thermoelectric refrigeration procedures as suggested by Manish [11].

### i. Active heat load

The active heat load ( $Q_{\text{active}}$ ) can be estimated using Equation (9).

$$Q_{\text{active}} = \frac{V^2}{R} = I^2 R \quad (9)$$

Where,  $Q_{\text{active}}$  is the active heat load (W),  $V$  is the applied voltage to cooling device,  $R$  ( $\Omega$ ) is the resistance of the device and  $I$  (A) is the current through the device.

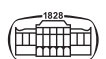

$$Q_{\text{active}} = 2.5^2 \times 4.5 = 28.125 \text{ W}$$

### ii. Conduction

The conductive heat load ( $Q_{\text{cond.}}$ ) can be calculated using Equation (10).

$$Q_{\text{cond.}} = k \times A \times \frac{dT}{dx} \quad (10)$$

Where,  $Q_{\text{cond.}}$  is the conductive heat load (W),  $k$  (W/m °C) is the thermal conductivity of the material,  $A$  ( $m^2$ ) is the cross-sectional area of the material,  $dx$  (m) is the distance of the heat path  $dT$  (°C) is the temperature difference across the path of heat.

$$Q_{\text{cond.}} = 1.5 \times 0.0016 \times \frac{22}{0.04} = 1.32 \text{ W}$$

### iii. Convection

The convective heat load ( $Q_{\text{conv.}}$ ) can be calculated using Equation (11).

$$Q_{\text{conv.}} = hA (T_{\text{amb.}} - T_{\text{cold}}) \quad (11)$$

Where,  $Q_{\text{conv}}$  is the convective heat load (W),  $h$  is the convective heat transfer coefficient (W/m<sup>2</sup> K),  $A$  ( $m^2$ ) is the cross-sectional area of material and  $T_{\text{amb}}$  is the ambient temperature (°K) and  $T_{\text{cold}}$  the temperature (°K) of the cold side.

$$Q_{\text{conv.}} = 137.5 \times 0.0016 \times (303 - 283) = 4.4 \text{ W}$$

### iv. Radiation

The radiative heat load ( $Q_{\text{rad.}}$ ) can be calculated using Equation (12).

$$Q_{\text{rad.}} = F_s \times \varepsilon \times \sigma \times A \times T_{\text{amb.}} \times T_c \quad (12)$$

Where,  $Q_{\text{rad.}}$  is the radiation heat load (W),  $F_s$  is the shape factor  $\varepsilon$  is the emissivity,  $\sigma$  ( $5.667 \times 10^{-8} \text{ W/m}^2\text{K}^4$ ) is the Stefan-Boltzmann constant,  $A$  ( $m^2$ ) is the area of the cooled surface,  $T_{\text{amb}}$  is the ambient temperature (°K) and  $T_{\text{cold}}$  is the temperature (°K) of the cold side.

$$\begin{aligned} Q_{\text{rad.}} &= 1 \times 1 \times 5.667 \times 10^{-8} \times 0.0016 \times 30 \times 20 \\ &= 5.44 \times 10^{-8} \text{ W} \end{aligned}$$

$$\text{Total load}(Q) = Q_{\text{active}} + Q_{\text{cond.}} + Q_{\text{conv.}} + Q_{\text{rad.}} = 33.84 \text{ W} \quad (13)$$

## 3. RESULTS AND DISCUSSION

This section presents the performance specification of TEM, the cooling temperature of the specimens per period, the amount of heat extracted from each specimen, the percentage distribution of the heat from each specimen and the COP of the thermoelectric refrigerator. The thermoelectric cooler that the experiment was based is a single-stage TEC. The COP of a single stage TEC ranges from 0.4 to 0.7 [12, 13].

Table 1. Performance specifications of the Thermoelectric module

Thermoelectric module type ( <i>inbc1-127.05</i> )	Dimensions (mm)			
Hot side Temp. (°C)	27.0	54.0	Length	40
I max. (Amps)	6.0	6.0	Width	40
Delta T max. (°C)	65.0	74.0	Height	4.0
V max. (Volts)	15.40	17.4		
Q max. (W)	51.4	57.4		

### 3.1. Performance specification of the thermoelectric module (TEM)

The specification of the TEM of the TEC used is presented in Table 1. *Inbc1-127.05* is the type of TEM used in the TEC. The maximum quantity of heat (Q max) that can be pumped by the TEC is 51–57 kJ as shown in Table 1, which can conveniently accommodate the range of heat (4–50 kJ) that was extracted from the specimens in Table 4. I max. of 6 A, is the current associated with the heat pumped by TEM can conveniently tolerate 2.5 A, which is the current of the power supplied to the TEM. Delta T max. (65–74°C) is the maximum temperature gradient produced between the hot and the cold side of the heat exchangers, which will accommodate the temperature 22°C, removed from the specimens that were cooled. The respective voltage across the cooler is denoted as V max. (15–17 V) this is quite larger than the 12 V of the power supplied to the TEM. Length, width and height refer to the dimensions of the TEM. The analysis of the specifications of the TEC indicates that the system used is appropriate for the loading involved in the experiment.

### 3.2. The rate of temperature reduction in the specimens during cooling for six hours

The temperatures of the test specimens before cooling is in the range 25–27°C. The thermoelectric cooler (TEC) was able to reduce the temperatures of the specimens to the range of 15–19°C in the first 30 min of cooling. After one (1) hour of cooling the specimens', temperature reduces to between 14 and 17°C, after two (2) hours the temperatures range become 9–14°C, it became 5–11°C after three (3) hours; it reduces to range between 5 and 9°C after four (4) hours of cooling. Tomato and banana has the highest cooling rate with temperature of 5°C after four (4) hours of cooling, followed by carrot with temperature of 6°C, followed by water (H<sub>2</sub>O), orange and lemon with temperature of 8°C and the least is apple and grape with 9°C. The temperatures of the specimens remained constant after cooling for four (4) hours as shown in Table 2 which shows that the temperatures for the fifth and sixth hours of cooling are the same as that of the fourth hour for all specimens.

The graph showing the cooling temperature of the specimens with their corresponding cooling period is shown in Fig. 5.



Table 2. The heat extracted from each item and the corresponding period of cooling

Samples	Mass (g)	Specific heat (kJ/kg K)	Temperature (°C) precooling	Period (h) of cooling and temperature (°C) after cooling						
				½ h	1 h	2 h	3 h	4 h	5 h	6 h
Lemon	372	3.81	26	19	17	13	9	8	8	8
Apple	95	3.72	26	17	16	14	10	9	9	9
Orange	232	3.81	26	18	16	13	9	8	8	8
Tomato	153	3.85	27	15	14	11	5	5	5	5
Carrot	82	3.89	26	15	14	9	8	6	6	6
Water	693	4.2	25	16	15	12	11	8	8	8
Grape	352	3.96	26	19	17	14	10	9	9	9
Banana	160	3.35	27	17	16	11	7	5	5	5

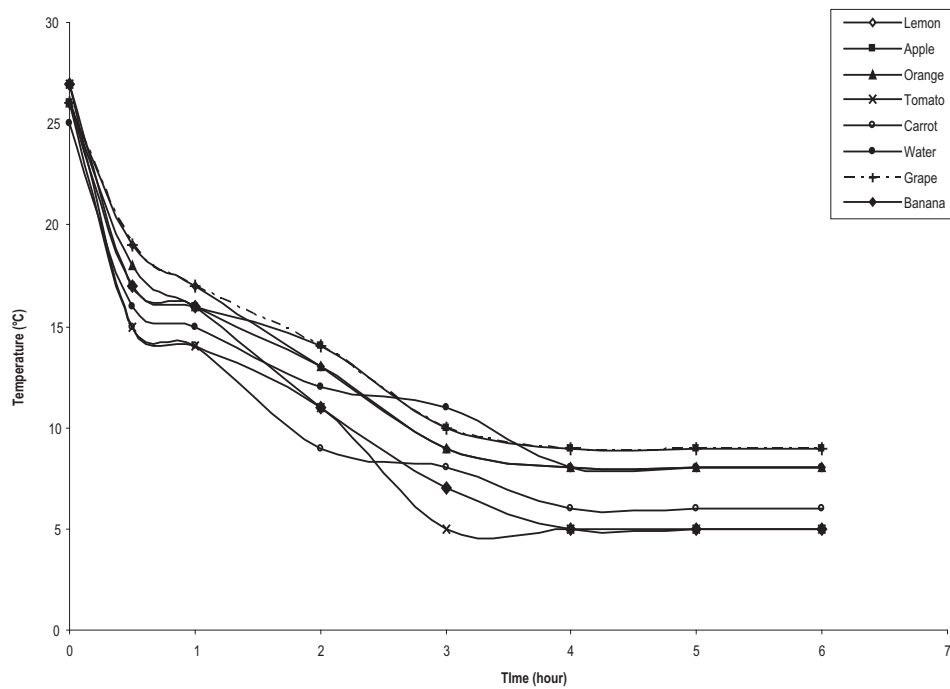

Fig. 5. The graph showing the variation curve of cooling to the period (hour) for each process

Table 3. The temperatures at the hot and cold sides of the thermoelectric module (TEM)

Period of operation	Temp. (°C) at the hot side	Temp. (°C) at the cold side	COP theoretical
1 h	32	21	1.91
2 h	30	13	0.77
3 h	26	10	0.63
4 h	26	10	0.63

### 3.3. The temperature gradients at the TEM during cooling for four hours

Table 3 presents the analysis of the temperature gradients at TEM during the cooling process. The temperature gained at the hot side of the thermoelectric module is of range 26–32°C and the temperature range at the cold side is 10–21°C. The theoretical COP decreases after the first 3 h of cooling process and became constant after the fourth hour

of cooling. The average COP after cooling for about 4 h is 0.99.

### 3.4. The load (kJ) extracted from the specimens during five hours of cooling

The minimum heat extracted from the specimens while cooling for the first 30 min is 3.18 kJ from apple followed by 3.51 kJ from carrot and the highest is 26.2 kJ from water. After 1 h of cooling, the heat extracted from water is 29 kJ, followed by lemon 12.76 kJ and the least is grape 2.25 kJ as presented in Table 4.

About 38 kJ of heat was removed from water after cooling for 2 h, followed by lemon with 18.4 kJ, followed by grape with about 17 kJ and the least is apple with 4.24 kJ. The heat removed after 4 h of cooling, has 49.48 kJ, as the highest from water followed by 25.51 kJ from lemon, 23.7 kJ from grape, 15.03 kJ from orange, 12.96 kJ from tomato, 11.79 kJ from banana, 6.38 from carrot and least is 6.01 kJ from apple. The total heat extracted from all the specimens



Table 4. The heat extracted from the specimens during the cooling process

Sample of specimens	Heat extracted (k J) from each specimen and the period of cooling (hr.)					
	½ h	1 h	2 h	3 h	4 h	5 h
Lemon	9.920	12.76	18.43	24.09	25.51	25.51
Apple	3.180	3.530	4.240	5.650	6.010	6.010
Orange	7.070	8.840	11.49	15.03	15.91	15.91
Tomato	7.060	7.660	9.420	12.96	12.96	12.96
Carrot	3.510	3.830	5.420	5.740	6.380	6.380
Water	26.20	29.11	37.84	40.75	49.48	49.48
Grape	9.760	2.550	16.73	22.30	23.70	23.70
Banana	5.360	5.900	8.580	10.72	11.79	11.79
Total	72.06	74.18	112.5	137.24	151.74	151.74

Table 5. Estimated average C.O.P of the system

Period of cooling (hour)	Heat extracted, Q (J)	Work Input, V.I.T (J)	C.O.P
1	84,162	108,000	0.7793
2	112,145	216,000	0.5191
3	137,247	324,000	0.4236
4	146,430	432,000	0.3389
Total			2.0609
Average			0.5152

after four (4) hours is 151.74 kJ and the temperature of each specimen remain constant even after further 1 h of cooling.

**3.5. The estimated COP<sub>Ref</sub> using Equations 1, 2 and 5**

The heat extracted from each refrigerated item considered as the refrigerating effect of the system, the work input and the corresponding COP obtained is presented in Table 5. The table summarizes the correlation between the quantity of heat extracted and the work input, and the corresponding COP in the cooling processes.

The C.O.P of the TER using Equations (1, 2 and 5) is 0.515 and the C.O.P of the system using Equations (6-8) is 0.529.

**3.6. The distribution of the heat extracted from the refrigerated items**

Figure 6 presents the percentage distribution of heat during the cooling process of one (1) hour. Water takes 39% of the heat extracted, followed by lemon with 17%, orange 12% and the least is grape with 4%.

Figure 7 shows the heat distribution among the refrigerated items during the cooling process of two (2) hours. Water takes 34% of the heat extracted, followed by lemon with 16%, grape 15% and the least is apple with 4%.

Figure 8 reveals that water has 30% of the heat distribution, followed by lemon with 18%, grape with 16% and the least is apple and carrot with 4%, during the cooling process of three (3) hours.

Table 2 shows that the refrigerated items have same temperature conditions after cooling for four (4) and five (5)

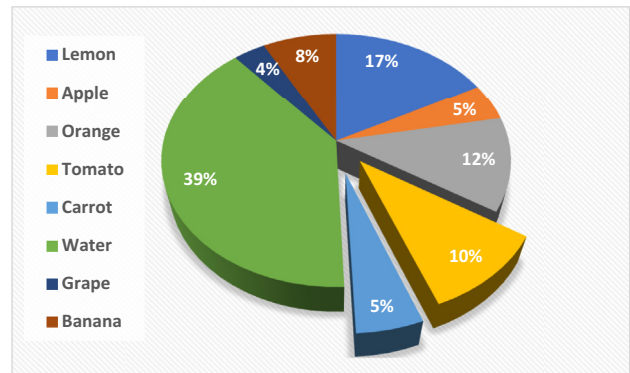

Fig. 6. Heat distribution for refrigerated fruits/vegetables during cooling for 1 h

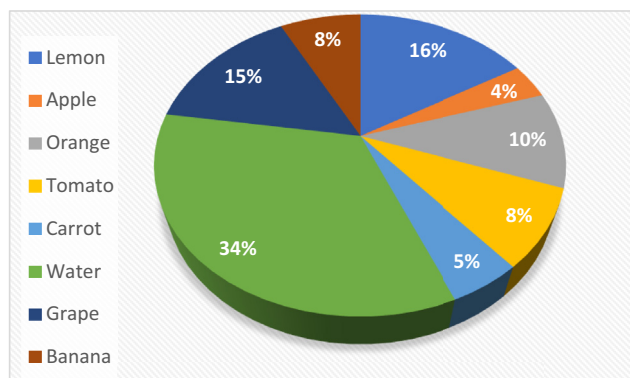

Fig. 7. Heat distribution for refrigerated fruits/vegetables during cooling for 2 h

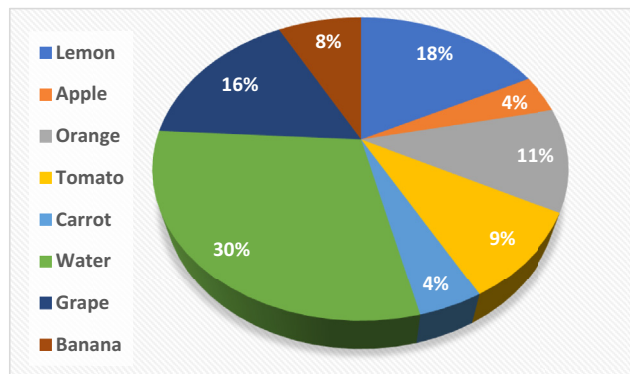

Fig. 8. Heat distribution for refrigerated fruits/vegetables during cooling for 3 h

hours, that is no temperature difference. Ditto the heat extraction from each item after four (4) hours cooling is same with that obtained after cooling for five (5) hours. This means the system reaches its maximum refrigerating capacity after 4 h. In Fig. 9, it could be observed that water produced 33% of the heat extracted after four (4) hours, this could be due to its high specific heat capacity. However, apple and carrot produced the least heat of 4%, which could be traceable to the two fruits being fleshy; their flesh prevents the conduction of heat from the fruits.



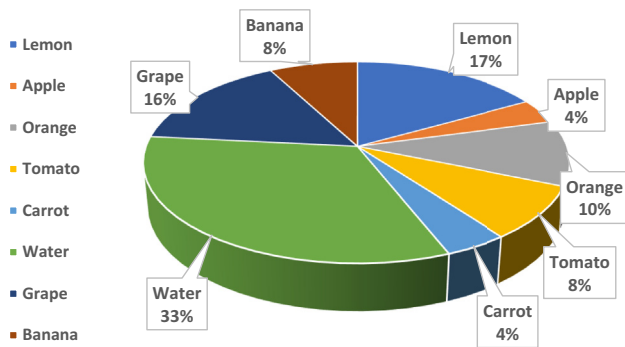

Fig. 9. Heat distribution for refrigerated fruits/vegetables during cooling for 4 h

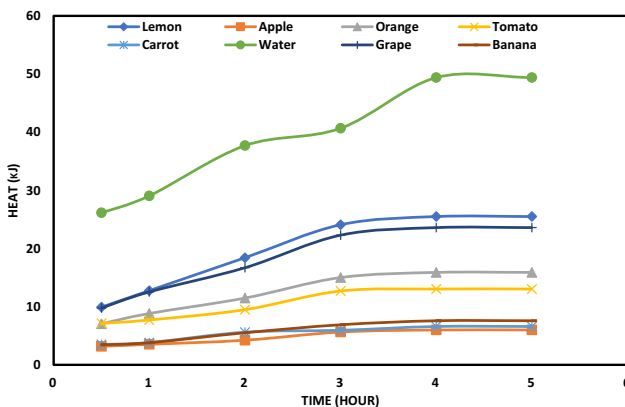

Fig. 10. The graph showing the pattern of Heat Extraction from the Food items

Figure 10 shows that the heat extracted from each refrigerated item increases with the period of cooling. Nevertheless, the highest fraction of heat extracted during the cooling process is 36% from water, followed by grape and lemon with 14% discretely, followed by orange and tomato with 10% concurrently, banana takes 7%, carrot takes 5% and apple 4%.

### 3.7. Comparison between the theoretical and practical COPs

Under the same experimental conditions (i.e. specimens are cooled periodically), COP theoretical has a range of 0.63–1.91 during cooling within 4 h, while COP practical varies from 0.34 to 0.78 within same period for COP theoretical as shown in Table 6. The COP practical is about 53% of the COP theoretical. The average COP practical obtained, agrees

Table 6. Comparison between the theoretical and practical

Period of cooling	COP (Practical)	COP (Theoretical)
1 h.	0.78	1.91
2 h.	0.52	0.77
3 h.	0.42	0.63
4 h.	0.34	0.63
Average	0.52	0.99

with the range (0.4–0.7) of COP stated for the single-stage TER [12, 13].

$$\text{Relative C.O.P} = \frac{\text{Actual C.O.P}}{\text{Theoretical C.O.P}} = 0.53$$

Theoretical COP is considered as an ideal performance that assumes 100%, while the practical COP is the actual COP, with performance less than 1, hence it is always less than the ideal (theoretical) COP.

## 4. CONCLUSION

The TER with a single stage TEM of *inbc1-127.05* type (with size 40 × 40 × 4.0 mm) using the electric current of 2.5 A, was used to cool fruits and vegetables from temperature of 27°C to a temperature of about 5°C after 4 h. The temperatures of TEM at the hot side increases from 28 to 32°C after 1 h, and after three (3) hours of the process, the heat pumped to the hot side diminishes and because of constant cooling effect of the fan, the temperature cools to 26°C, while the temperature inside the cabin decreases from 25 to 10°C after 3 h of cooling process. The theoretical COP decreases from 1.99 to 0.63 after 3 h. The average theoretical COP was determined to be 0.99 and the average practical COP was determined to be 0.52, this consents with the reason theoretical COP is considered as being ideal because it assumes performance of 100%. The actual (practical) COP agrees with the range 0.4–0.7 given to be the COP range for a single-type TER according to Marlow [12] Industry for thermoelectric refrigerators and Loan and Calin [13]. This study presents the percentage of the practical COP to the theoretical COP to be about 53%. The application of this investigation is to determine the capacity of every thermoelectric refrigerator or cooler, that is appropriate for different operations. The single stage TEC with COP of 0.52 is suitable for the preservation of drugs and medication that should be stored at cool temperature range between 15 to 8°C; then a TEC of better COP can be used to preserve drugs and medication that should be stored at refrigeration temperature between 8 and 2°C [14].

*Declaration of interest:* The authors declare no conflicting or competing interests with anyone whatsoever that could have appeared to influence the work reported in this paper.

## ACKNOWLEDGEMENTS

The authors are very grateful to the technologists in the thermal energy Laboratory of Landmark University for their efforts in ensuring that the experimentation was a success.

## REFERENCES

[1] R. A. Ibikunle, *Development of Thermoelectric Refrigerator*, M.Eng. Thesis, Federal University of Technology, Akure Nigeria, 2011.

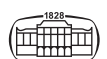

- [2] T. M. Tritt and M. A. Subramanian, "Thermoelectric materials, phenomena and applications: a bird's eye view," *J. Mat. Sci.*, vol. 31, pp. 188–98, 2006. <https://doi.org/10.1557/mrs2006.44>.
- [3] H. Sofrata, "Heat rejection alternatives for thermoelectric refrigerators," *J. Energy Convnt. Manage.*, vol. 37, pp. 269–80, 1996.
- [4] S. Godfrey, "An introduction to thermoelectric coolers," *Articles, Coolers, Design, TECs, Test & Meas.*, available at: <https://www.electronics-cooling.com/1996/09/an-introduction-to-thermoelectric-coolers/> (accessed 15 July 2020).
- [5] X. F. Zheng, C. X. Liu, Y. Y. Yan, and Q. Wang, "A review of thermoelectric research – recent developments and potentials for sustainable and renewable energy applications," *J. Renew. Sust. Energy Rev.*, vol. 32, pp. 486–503, 2013. <https://doi.org/10.1016/j.rser.2013.12.053>.
- [6] A. C. Sulaiman, N. A. Mohd Anin, M. H. Basha, M. S. Abdul Majid, N. F. Mohd Nasir, and Z. Zaman, "Cooling performance of thermoelectric cooling (TEC) and applications: a review," in *MATEC Web of Conferences*, vol. 22, 03021, 2018, <https://doi.org/10.1051/mateconf/201822503021>.
- [7] C. S. Aqilah, M. A. N. Amri, H. B. Mohd, and S. A. Mohd, et al. "Cooling performance of thermoelectric cooling (TEC) and applications: a review," in *MATEC Web of Conferences*, vol. 225, 03021. 2018, <https://doi.org/10.1051/mateconf/201822503021>.
- [8] G. Sujith, V. Antony, A. Ashish, M. Rejo, G. Renchi, and V. Vishnu, "Design and fabrication of thermoelectric refrigerator with thermosiphon system," *Int. J. Sci. Eng. Appl. Sci.*, vol. 2, 2016, available at: <https://silo.tips/download/design-and-fabrication-of-thermoelectric-refrigerator-with-thermosiphon-system> (accessed 7 July 2020).
- [9] S. Jugsujinda, A. Vora-ud, and T. Seetawan, "Analyzing of thermoelectric refrigerator performance," in *Proced. Eng.*, vol. 8, pp. 154–9, 2011, <https://doi.org/10.1016/j.proeng.2011.03.028>, available at: [https://www.researchgate.net/publication/251716178\\_](https://www.researchgate.net/publication/251716178_) (accessed 15 July 2020).
- [10] A. G. Ahmed, A. A. Yaser, M. Osama, and F.A. Ahmed, "Experimental study of a thermoelectric-(vapor compression) hybrid domestic refrigerator," in *Proceedings of ICFD14: Fourteenth International Conference of Fluid Dynamics 2-3 April 2021*, Fairmont Nile City Hotel, Cairo, EGYPT.
- [11] N. Manish, and T. Brajesh, "Experimental studies on thermoelectric refrigeration system," in *International Conference on Cutting Edge Technologies 30 April 2019*, Greater Noida, UP, India.
- [12] Marlow (Thermoref. Industry), "Guide to working with thermoelectric materials", available at: <https://info.marlow.com/guide-to-working-with-thermoelectric-materials> (accessed 18 July 2020).
- [13] S. Loan, and S. Calin, *Solar Heating and Cooling Systems: Fundamentals, Experiments and Applications*, Amsterdam Academic Press, 2017.
- [14] ONTARIO, *Tips for Proper Storage of Medications. 2000/2020*, Ontario Pharmacists Association, available at: <https://www.opatoday.com/medication-storage-tips#:~:text=A%20medication%20that%20should%20be,10%20to%20%2D25%20degrees%20Celsius> (accessed 17 July 2020).

