

Single- and double-electron detachment from H^- in collisions with He

L. Víkor,^{1,2*} L. Sarkadi,¹ F. Penent,³ A. Báder,¹ and J. Pálinkás^{1,2}

¹*Institute of Nuclear Research of the Hungarian Academy of Sciences (ATOMKI), H-4001 Debrecen, P.O.Box 51, Hungary*

²*Department of Experimental Physics, Lajos Kossuth University, Debrecen, Bem tér 18/a, Hungary*

³*Laboratoire de Dynamique Moléculaire et Atomique, Université Paris 6, Paris Cedex 05, France*

(Received 25 March 1996)

The single- and double-electron detachment processes have been studied for 85 keV H^- on He collisions measuring the energy spectra of the electrons emitted in forward direction. In the spectrum belonging to the single-electron loss (SEL) the nonresonant part (cusp) has been resolved from the resonant part [lines from the $(2s2p)^1P^o$ shape resonance of H^-]. The ratio of the integrated yield of the double-electron loss (DEL) to that of SEL was found to be 0.36 ± 0.02 . The yield of the cusp in the SEL spectrum was found to be surprisingly small, only $(70 \pm 20)\%$ of the yield of the cusp in the DEL spectrum. The formation of the cusp in SEL is interpreted as a result of dipolar interaction between the electron and the outgoing H^0 atom. [S1050-2947(96)10309-7]

PACS number(s): 34.50.-s, 34.60.+z

I. INTRODUCTION

Electron detachment is the dominant inelastic process in negative ion collisions. The collision of H^- with He represents a fundamental system for study of this process. From H^- the electron detachment can proceed via *single-electron loss* (SEL):

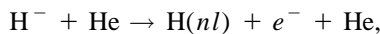

and *double-electron loss* (DEL):

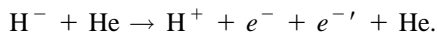

The electron(s) is (are) mainly detached with a small energy from the H^- ion. In the energy spectrum of the detached electrons emitted in forward direction taken without separation of SEL and DEL (noncoincidence experiments), a pronounced structure appears in the spectrum around $v_e = v_i$, where v_e and v_i are the electron and the ion velocity, respectively [1–3]. The structure consists of a sharp peak located exactly at $v_e = v_i$, known as the cusp, and two peaks on the wings of the cusp which result from the decay of the $(2s2p)^1P^o$ shape resonance of H^- above the $H(n=2)$ threshold (see the energy-level diagram in Fig. 1).

The origin of the cusp peak appearing in the energy spectra of electrons ejected in atomic collisions is well known. The peak observed in the laboratory-frame measurements is due to the *finite (nonzero)* cross section for the electron emission at the threshold in the projectile reference frame. The peak is a singularity which comes from the frame transformation: the cross section in the projectile frame is enhanced by the factor v_e/v_e' where v_e and v_e' are the electron velocity in the laboratory and in the projectile frame, respectively. According to the Wigner threshold law [4], nonzero cross section occurs for long-range forces, namely for those cases when the potential does not decay faster than r^{-2} , i.e., for

the Coulombic [5] and for the dipolar [6] interactions. In the case of the double-electron detachment from H^- the cusp appearing in the DEL spectrum is due to the long-range Coulomb force between one of the ejected electrons and the outgoing proton. For SEL the outgoing projectile is *neutral*, the force has short range, and, therefore, no cusp is expected in this case. However, if the outgoing H^0 atom is in an excited state, it may interact via a *dipolar* potential. For example, for the $n=2$ excitation the collisional mixing of the degenerated $2s$ and $2p$ states in H^0 may lead to a permanent electric dipole moment. In this special case the question is whether the range of the interaction is long enough for cusp production.

Liu and Starace [6] calculated doubly differential cross sections for SEL in fast collisions of H^- with He. They used the hyperspherical coordinate method to determine the electronic wave functions of the $H(n=2)-e^-$ system, and identified individual hyperspherical channels in the projectile frame leading to “cusp,” “shape resonance,” and/or “shoulder” behavior in the laboratory-frame cross sections. One of the findings of this work was that the channels giving

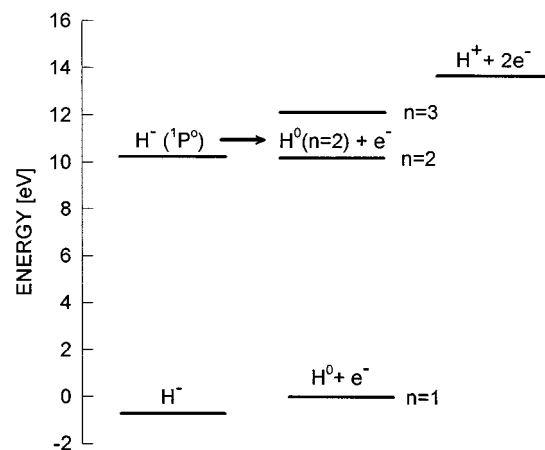

FIG. 1. Energy-level diagram of H^- . The arrow shows the resonant detachment.

*On leave from the Institute of Physics, P.O.Box 57, Belgrade, Yugoslavia.

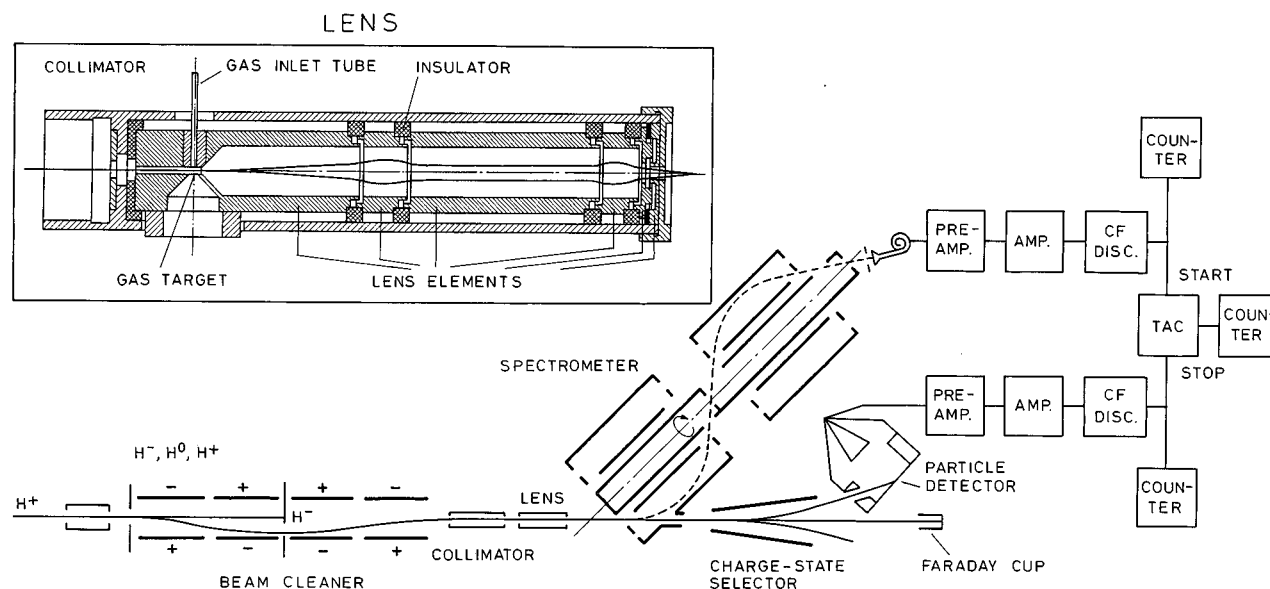

FIG. 2. The scheme of the experimental setup. Inset: the electrostatic lens used for acceleration of the electrons and to provide good angular resolution for the electron detection.

rise to the cusp are characterized by attractive radial hyper-spherical potentials. The potentials were shown to have asymptotically the form of the dipolar interaction resulting from the degeneracy of the $H(n=2)$ states.

In view of the above considerations, the existence and properties (intensity, shape) of the cusp in the collisional *single* electron detachment of H^- is a fundamentally interesting question. For the experimentalists its study is a challenge, partly because one has to apply coincidence technique to separate SEL from DEL, and partly because of the large "background" due to the shape resonance lines in the SEL spectrum which can be resolved only with good energy and angular resolution, as will be discussed in the next section.

For the study of the origin of the cusp production in SEL one cannot avoid the coincidence measurement. In some of the previous works dealing with the electron detachment from H^- (see, for example, [7,8]) it was assumed that DEL is a minor and negligible effect, and consequently the total electron spectrum can be identified with the SEL spectrum. This assumption is highly questionable, because although DEL is a two-electron process (and thereby it is thought to be weak), it is induced by the Coulomb force which is stronger than the dipolar force in case of SEL. The existence of the cusp in SEL was first proved by Penent *et al.* [9], who excluded the DEL channel detecting the electrons in coincidence with the Lyman- α photons emitted from the decay of $H(2p)$ formed in the collisions of H^- ions with He, Ne, and Ar atoms at 4 keV. It was found that the cusp in the coincidence spectrum had considerably smaller intensity than the cusp in the "singles" spectrum, indicating a non-negligible contribution of DEL. We remark that in the experiment of Penent *et al.* only that part of the SEL cusp which belongs to $H(2p)$ atoms in the final state was measured, and no information was obtained for the contributions of $H(2s)$ and other excited states. In this way the role of DEL could not be established unambiguously from comparison of the coincident and singles spectrum.

Here we report on good energy- and angular-resolution

measurement of both SEL and DEL for 85 keV H^- on He collisions made at zero degree observation angle. The two reaction channels were identified measuring the electrons in coincidence with the charge-state selected outgoing projectiles. To the best of our knowledge, coincidence experiment with high angular resolution of both SEL and DEL has not been reported until now in the literature. The emphasis of this paper is put on the cusp electrons in SEL, as a continuation of our interest for the more general problematics of the cusp with neutral outgoing atoms in the final state. In our previous works we observed the cusp in target ionization [i.e., in the process known as *electron capture into the continuum states of the projectile* (ECC)] at impact of neutral helium [10] and hydrogen [11] atoms, as well as in *transfer ionization* (TI) induced by He^+ ions [12] and protons [13]. The occurrence of the cusp in these collisions with neutral outgoing atoms in the final state is still not understood, although several attempts have been made to explain the observations [13–18]. The study of the electron detachment from negative ions in the present work represents another approach to the above problem.

II. EXPERIMENTAL SETUP AND METHOD

The basic apparatus and the measuring procedure have already been described in detail [19] and only the main features will be summarized here (see also Fig. 2). The crucial modification of the setup for this experiment was the use of an *electrostatic lens* for the electrons [20] by which we could reduce the acceptance (half) angle of the electron detection to a value smaller than 0.6° , preserving at the same time the good detection efficiency. The use of the method of zero-degree electron spectroscopy [21] allowed us to get information on ejection of extremely low-energy electrons in the projectile reference frame due to the kinematic amplification of the electron energy resulting from the frame transformation. With the good angular resolution achieved by the lens we could resolve the $(2s2p)^1P^o$ shape resonance lines from

the cusp to such an extent that the contribution of the cusp peak to the total SEL could be determined by a fitting procedure using a mathematical model [22].

A proton beam of 85 keV energy was produced by the 1.5 MV Van de Graaff accelerator of the Institute of Nuclear Research of the Hungarian Academy of Sciences (ATOMKI). The ions passed through a gas cell where part of the H^+ ions were transformed into H^- ions via charge exchange. The created negative ion beam was separated from the H^+ and H^0 beams by a four-component electrostatic charge-state selector (denoted as ‘‘beam cleaner’’ in Fig. 2).

The H^- ions crossed an effusive beam He gas target placed inside the first element of the electrostatic lens (see the inset of Fig. 2). The lens was constructed specially for purposes of zero-degree electron observation. It has cylindrical symmetry, and its axis is defined by the direction of the projectile beam. It is placed in front of an electron spectrometer, and its image volume coincides with the source volume of the electron spectrometer.

We used the lens in the present experiment for two reasons. First, we used it to increase the energy of the electrons by factor of 2. This was important, because the detection efficiency and the stability of the applied electron spectrometer was better at larger energies, and by the acceleration we could reduce also other disturbing effects like charging up, differences in contact potentials, etc. The second and most important reason was that to resolve the lines from the $(2s2p)^1P^o$ shape resonance one needs not only good energy resolution but also good angular resolution. In the projectile reference frame the energy distribution of the electrons emitted from this resonance has a peak maximum at 18 meV [23]. This small energy is kinematically amplified to a few eV in respect to the cusp position when the electrons are observed in the laboratory frame. The two peaks corresponding to forward and backward emission, however, can be resolved only if the acceptance (half) angle of the electron observation is smaller than a ‘‘critical’’ angle $\Delta\vartheta_c$, otherwise all the electrons emitted to 4π will form one single peak. From the velocity diagram of the frame transformation (see, e.g., [3]) one can get easily that for 85 keV proton impact $\Delta\vartheta_c = 1.2^\circ$. To provide a smaller acceptance angle for the combined lens and spectrometer system than $\Delta\vartheta_c$, the lens was operated in the ‘‘angular magnification’’ mode [20].

As an electron spectrometer we used a distorted field double-stage cylindrical mirror analyzer [24]. The acceptance angle and the relative energy resolution of the spectrometer are defined by two apertures located at the exit part. The acceptance (half) angle of the spectrometer was 2° , the angular magnification obtained by the lens was 3.5, thus the resulting final angular acceptance was about 0.6° . The relative energy resolution of the spectrometer was 0.6%. The energy-analyzed electrons selected by the apertures are detected by a channel electron multiplier.

The outgoing projectiles are charge-state analyzed by an electrostatic deflector and detected with a fast particle detector [25]. SEL and DEL were identified detecting the electrons in coincidence with the outgoing H^0 and H^+ particles, respectively. The measured electron spectra were corrected for the contribution of random coincidence events and for the energy-dependent efficiency of the electron detection.

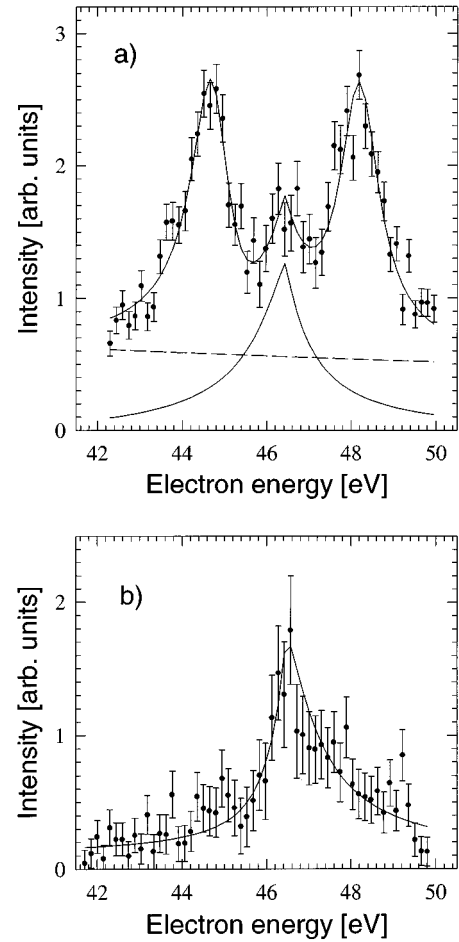

FIG. 3. Energy spectra of electrons emitted in forward direction from collisions of 85 keV H^- ions with He atoms. Parts (a) and (b) show spectra measured in coincidence with the outgoing H^0 and H^+ particles, respectively. The curves through the data are results of fits (see text). In part (a) the cusp and the linear background (dashed line) obtained from the fit are also plotted.

III. RESULTS AND DISCUSSION

Figure 3 shows the obtained SEL and DEL electron spectra. For SEL it can be seen that the $^1P^o$ resonance lines are well resolved. The appearance of the cusp as a small central peak in the SEL spectrum supports the previous observation of Penent *et al.* [9] as well as the theoretical prediction of Liu and Starace [6] that the cusp exists also for dipolar interaction.

We remark here that proving the existence of the cusp, we had to consider the following ‘‘background’’ process. Although we used a charge-state selector to provide a clean incoming negative ion beam, part of the beam neutralized before it entered the target region. The neutralization is due to collisions with the atoms of the residual gas and scattering from the edges of the beam collimator. The neutral H^0 atoms produce a cusp with large cross section via the ECC process [11] in collisions with the target atoms. Since the outgoing projectile for the latter collisions is the same as for the single electron detachment from H^- , the coincidence measurement cannot distinguish between the two contributions. To determine the background due to the neutral part of the ion beam, we performed a separate coincidence measurement in which

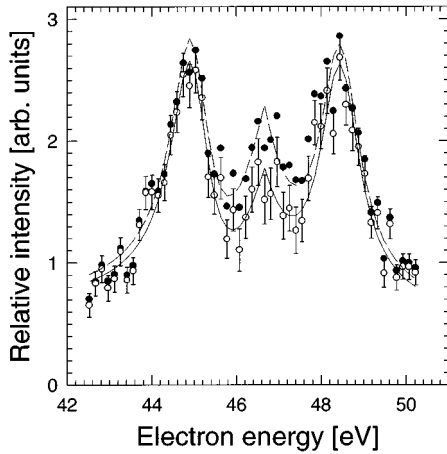

FIG. 4. The effect of the H^0 content of the H^- beam on the measured SEL spectrum. Full and open circles denote spectra before and after subtraction of the background due to the H^0 contamination of the beam, respectively.

we took a spectrum for the ECC cusp induced by neutral H^0 atoms. Normalizing this spectrum to the number of the incoming atoms, we could determine the relative yield of the background corresponding to the number of the neutral atoms in the H^- beam. Figure 4 shows the SEL spectrum before and after subtraction of the background. It is seen that the correction is not negligible in the cusp region, but the peak still exists in the corrected spectrum.

If the pressure of the target gas is too large, the neutralization of the negative ion beam may also take place due to interaction with the atoms of the target gas. In this case part of the observed electrons are produced in double collisions: the neutralization of the projectile in a first collision is followed by a second collision in which electrons are produced via ECC. We checked the contribution of the double collisions repeating the coincidence measurement at half value of the target gas pressure. We found that the shapes of the coincidence spectra obtained at different pressures were identical, indicating that the effect of the double collisions was negligible.

We checked the background due to neutral part of the beam as well as the contribution from the double collisions also for the DEL spectrum. We found that both effects were negligible in this case.

It is worthwhile to mention that the shape of the SEL spectrum obtained in the present work is very similar to that obtained by Penent *et al.* [9] in their experiment detecting the electrons in coincidence with the Lyman- α photons of H ($2p$). In both experiments the cusp is strongly suppressed compared to the resonance lines. Although it is hard to compare spectra measured at very different impact energies (4 and 85 keV), the similarity of the shapes is in accordance with the picture that in these collisions the cusp is induced by dipolar interaction between the detached electron and the outgoing H^0 atom. As it was mentioned in the Introduction, permanent electric dipole moment can be formed only in excited states. We may assume that in the collision mainly the $n=2$ states are excited. This assumption has two consequences. First, as one can see from Fig. 1, the excitation energy for the $(2s2p)^1P^o$ shape resonance and that for the

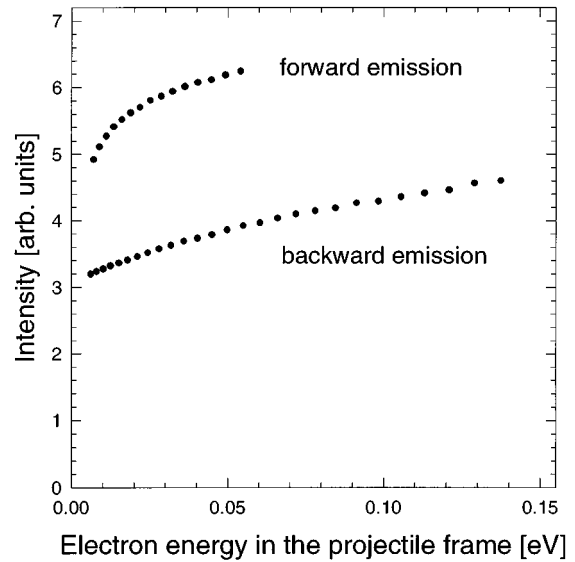

FIG. 5. Energy distribution of the electrons emitted during the double electron detachment of H^- in the projectile reference system. The points were obtained transforming the curve fitted to the DEL data [see Fig. 3(b)] from the laboratory frame to the projectile frame.

cusp production with simultaneous $n=2$ excitation of H^0 are almost the same. Since the dependence of a collision process on the impact energy is predominantly determined by the transferred energy, the ratio of the resonance- and cusp-production cross section is expected to depend weakly on the collision energy. Second, at a fixed impact energy the spectrum measured in coincidence with the Lyman- α photons should be roughly the same as that obtained in coincidence with the scattered H^0 atoms (neglecting the contribution from the $2s$ excitation). The similar spectrum shapes observed in the two experiments support the dominance of the $n=2$ excitations. We remark here that direct (i.e., nonresonant) electron loss may take place also without excitation, but due to a lack of long-range interaction the cusp is missing in this case, and the contribution of this process to the spectrum is only a smooth “background” (see Fig. 3).

As far as the DEL spectrum is concerned, we can say according to Fig. 3 that the double-electron detachment is not negligible. The ratio of the integrated yield of DEL to that of SEL was found to be 0.36 ± 0.02 . The most striking feature of the DEL spectrum is the large asymmetry of the peak: the electron yield is strongly enhanced towards higher energies. This corresponds to a preferred electron emission in forward direction in the projectile reference system as can be seen from Fig. 5, where we present the DEL spectrum (more precisely, the distribution obtained from a *fit* of the measured spectrum; see later) after transforming it to the projectile system. The asymmetry of the DEL cusp was observed by Duncan *et al.* [7] in 0.5 MeV H^- on He collisions. Sørensen *et al.* [26] studied the double-electron loss from H^- in the energy range from 0.1 to 2.0 MeV in collisions with He, Ar, and Xe. These authors found that for He target the asymmetry of the DEL cusp increased with decreasing projectile energy.

The most probable reason for the asymmetry of the DEL cusp is the correlated motion of the two electrons in the

Coulomb field of the proton. To the best of our knowledge, the interesting problem of the cusp production in DEL at H^- impact has not been analyzed theoretically yet, and the interpretation of the asymmetry of the peak is still missing.

The curves through the experimental data in Fig. 3 are the results of a fitting procedure using the mathematical model of Závodszy *et al.* [22]. The model is based on the formalism introduced originally by Shore and further developed by Balashov *et al.* [27] for description of the electron emission via a nonresonant and a resonant process. In this formalism the doubly differential cross section (DDCS) in the projectile reference frame is expressed as

$$\left(\frac{d^2\sigma}{dE'_e d\Omega_{e'}} \right)_p = \left(\frac{d^2\sigma}{dE'_e d\Omega_{e'}} \right)_p^{\text{NR}} + \frac{\alpha(\mathbf{k}'_e)\varepsilon + \beta(\mathbf{k}'_e)}{1 + \varepsilon^2}, \quad (1)$$

where $(d^2\sigma/dE'_e d\Omega_{e'})_p^{\text{NR}}$ is the cross section of the nonresonant (direct) electron detachment, Ω'_e is the solid angle of the electron emission, $\varepsilon = 2(E'_e - E_r)\Gamma^{-1}$ is the reduced energy variable, E'_e and \mathbf{k}'_e are the energy and the momentum of the ejected electron in the projectile reference frame, and E_r and Γ are the energy and the width of the resonance. $\alpha(\mathbf{k}'_e)$ and $\beta(\mathbf{k}'_e)$ are the so-called Shore parameters which determine the intensity of the resonant process relative to the nonresonant process, and account also for the *interference* between the direct and resonant ionization amplitudes.

The transformation of the nonresonant cross section to the laboratory frame may lead to a cusp, as it was discussed above. Due to the fact that the cusp is a singularity, the result of the transformation depends largely on the transmission function and the angular acceptance of the spectrometer, therefore it is difficult to compare the observed cusp shape with that predicted by the theories. To overcome this difficulty, Meckbach *et al.* [28] introduced a series expansion method. The advantage of the method is that one can characterize the cusp by a set of expansion parameters which are free of instrumental effects.

The series expansion of the nonresonant cross section has the form

$$\left(\frac{d^2\sigma}{dE'_e d\Omega_{e'}} \right)_p^{\text{NR}}(\mathbf{k}'_e) = \sum_{n,l=0}^{\infty} c_{nl}(v_p) \left(\frac{v'_e}{v_p} \right)^n P_l(\cos\vartheta'_e), \quad (2)$$

where $c_{nl}(v_p)$ are the series expansion coefficients, v'_e and ϑ'_e are the velocity and the emission angle of the ejected electron in the projectile reference frame, v_p is the velocity of the projectile, and P_l are the Legendre polynomials. We remark that the cusp can be described with the first few terms in Eq. (2), because v'_e is small in the cusp region, and the electron emission is a slowly varying function of the angle in the projectile frame.

Závodszy *et al.* [22] generalized the above method for the Shore parameters:

$$\alpha(\mathbf{k}'_e) = \sum_{n,l=0}^{\infty} a_{nl}(v_p) \left(\frac{v'_e}{v_p} \right)^n P_l(\cos\vartheta'_e), \quad (3)$$

$$\beta(\mathbf{k}'_e) = \sum_{n,l=0}^{\infty} b_{nl}(v_p) \left(\frac{v'_e}{v_p} \right)^n P_l(\cos\vartheta'_e). \quad (4)$$

These series converge again rapidly, if the resonance is close to the cusp. We remark that from the decay of the resonance alone an almost isotropic angular distribution is expected, but the interference with the direct process may lead to a strong dependence of the resonant part of the DDCS on the electron emission angle.

The final expression to be compared directly with the experimental data is obtained transforming the DDCS of Eq. (1) to the laboratory reference frame, integrating the transformed DDCS over the acceptance angle of the spectrometer and convoluting it with the spectrometer transmission function. The result contains the a_{nl} , b_{nl} , and c_{nl} series expansion coefficients explicitly [22]. The coefficients can be regarded as free parameters of the ‘‘theoretical’’ function of the electron yield which can be fit to the experimental data. From the result of the fit the primarily angular and velocity distribution of the electron emission in the projectile frame can be reconstructed using Eqs. (1)–(4).

Applying the above formalism to our SEL data, our primary aim was to extract the cusp from the spectrum. During the fitting we realized that the series expansion given by Eqs. (3) and (4) is too general, since it allows that the DDCS takes nonzero values at $v'_e=0$ also for the resonant part in the projectile system. This has the consequence that the *resonant* part may also contribute to the cusp. However, according to Liu and Starace [6], the shape resonance does not contribute to the cusp for two reasons: it has zero cross section at the threshold, and it is characterized by *repulsive* radial hyper-spherical potential at large distances. To prevent the occurrence of the cusp from the shape resonance, we made the $\alpha(\mathbf{k}'_e)\varepsilon + \beta(\mathbf{k}'_e)=0$ restriction for the Shore parameters at $v'_e=0$. In the series expansions of Eqs. (3) and (4) this condition is automatically fulfilled for the $n \neq 0$ terms. For the $n=0$ terms, using the definition of the reduced energy variable $\varepsilon = 2(E'_e - E_r)\Gamma^{-1}$, from the above restriction we get the relationship $b_{0l}/a_{0l} = 2E_r\Gamma^{-1}$.

From the fitting procedure applied to the SEL and DEL data (see Fig. 3) we obtained the following results. We achieved a satisfactory fit retaining the $n, l=0, 1$ terms for both the resonant and the nonresonant part of DDCS. The ratio of the intensity of the cusp in SEL to the total SEL yield is 0.25 ± 0.06 . The intensity ratio for the cusps in SEL and DEL is 0.7 ± 0.2 . This latter result, i.e., that the SEL cusp has smaller intensity than the DEL cusp, is in accordance with the picture that the former is induced by the dipolar interaction which is weaker than the Coulomb interaction in case of DEL. The values of the series expansion parameters obtained from the fitting are listed in Table I. We note that the poor statistics of the data allowed us to determine only the $n, l=0$ coefficients with an acceptable accuracy (20% in average). The errors of the other coefficients are larger than 100% except for c_{01} , whose error is 75%. This means that from the measured data we could not extract reliable information for the cusp shapes, especially in the case of SEL. Anyhow, as it is seen in Fig. 3, from the fitting we got a symmetric shape for the SEL cusp. For DEL the observed asymmetry of the cusp (see above) is related to the large positive value of the ratio c_{01}/c_{00} which is 0.4 according to Table I. This value qualitatively follows the tendency shown by the data of Sørensen *et al.* [26] (for c_{01}/c_{00} these authors

TABLE I. The series expansion coefficients obtained from fits to the measured spectra.

	a_{00}	a_{01}	a_{10}	a_{11}	b_{00}	b_{01}	b_{10}	b_{11}	c_{00}	c_{01}	c_{10}	c_{11}
SEL	32	0	1000	-600	57	0	0	350	14	-3	-140	0
DEL	-	-	-	-	-	-	-	-	25	10	150	-100

used the notation β_1). Fitting the SEL spectrum, we considered the energy and width of the resonance also as free parameters. The obtained values $E_r = 16.8 \pm 1.5$ meV and $\Gamma = 19 \pm 2.5$ meV are in reasonable agreement with the findings of the previous experiments dealing with the collision- and photon-induced electron detachment of H^- as well as with the results of electron-scattering measurements made on H^0 [1–3,23]. For the a_{01}/a_{00} and b_{01}/b_{00} ratios, which are related to the forward-backward asymmetry of the electron emission from the decay of the resonance, we got zero values, i.e., it seems that the isotropic angular dependence characteristic for the resonance is not affected by the interference with the direct electron detachment.

At present we cannot compare the above results with theoretical calculations. The realistic description of the single- and double-electron detachment of H^- represents a challenge for the theory. The main difficulty is that for both SEL and DEL the use of *correlated* wave functions seems to be unavoidable, and, in addition to this, the collision process probably cannot be treated by a simple perturbational method (like the first-Born approximation) due to the small collision velocity. To achieve at least some level of the understanding, however, we felt it necessary to analyze in more detail the phenomenon of the collision-induced electric dipole moment in H^0 , as the most probable process which gives rise to the cusp in the SEL spectrum.

The collision-induced electric dipole moment is a special feature of the collisions involving hydrogen atoms. The formation of a permanent dipole moment in hydrogen can be traced back to the near degeneracy of the different orbital angular momentum l -states belonging to the same principal quantum number n . Due to the degeneracy, not only the magnetic substates but also the l -states are *coherently* excited in the collision. The coherent excitation of the l -states can result in a shift of the center-of-charge of the electron cloud with respect to the proton position, i.e., an electric dipole moment can be formed. Several experimental and theoretical works have been devoted to study the collision-induced electric dipole moment in the excitation of hydrogen in direct and charge exchange processes (see, e.g., Siegmann *et al.* [29] and references therein).

In the following we regard the $n=2$ excitation. The wave function has the form

$$\Psi(n=2) = f_{00}|2s_0\rangle + \sum_{m=-1}^{m=+1} f_{1m}|2p_m\rangle, \quad (5)$$

where f_{lm} are the excitation amplitudes. Since in the hydrogen atom the energies of the $|2s_0\rangle$ and $|2p_m\rangle$ states are nearly equal, the electric charge distribution corresponding to Ψ is stationary. The electric dipole moment belonging to this charge distribution is expressed as

$$\mathbf{D} = -|e|\langle\Psi|\mathbf{r}|\Psi\rangle, \quad (6)$$

where \mathbf{r} is a position vector pointing from the proton to the electron, and e is the elementary charge. Evaluating this expression one gets that only the z component of \mathbf{D} is different from zero. Furthermore, only the $|2s_0\rangle$ and $|2p_0\rangle$ states contribute to the dipole moment as is seen from the following simple formula of D_z (given in atomic units) [30]:

$$D_z = 6|f_{00}||f_{10}|\cos(\alpha_{00} - \alpha_{10}), \quad (7)$$

where α_{lm} are defined by $f_{lm} = |f_{lm}|\exp(i\alpha_{lm})$. It is interesting that the maximum dipole moment which can be formed by the coherent excitation of the $n=2$ states is quite large: $D_z^{\max} = 3$, if $|f_{00}| = |f_{10}| = 1/\sqrt{2}$, $\alpha_{00} - \alpha_{10} = 0$, and $f_{11} = f_{1-1} = 0$.

To visualize the dipole moment arising from the coherent excitation of the $2s$ and $2p$ states, in Fig. 6 we plotted in three dimensions the electron probability distribution belonging to $\Psi(n=2)$ for a case when the dipole moment has nonzero value. The plot is a *polar diagram* which shows the probability density of the electron at a given direction integrated over the radial coordinate:

$$\rho(\vartheta, \phi) = \int_0^\infty dr r^2 \Psi^*(r, \vartheta, \phi) \Psi(r, \vartheta, \phi). \quad (8)$$

Since we made the plot only for demonstration, for the sake of simplicity in evaluation of Eq. (8) we considered only real excitation amplitudes. We took $f_{00} = 0.45$ and $f_{10} = 0.74$ from which $D_z = 2.0$ according to Eq. (7). Although the $|2p_{11}\rangle$ and $|2p_{1-1}\rangle$ states do not contribute to the dipole moment, to see their effect on the charge distribution we included also these states with equal amplitudes $f_{11} = f_{1-1} = 0.35$. According to the figure, the obtained charge distribution is largely asymmetric along the z -axis with respect to the proton position. The shift of the center-of-charge is well seen in the x - z and y - z sections of the three-dimensional plot.

According to the experiments, large dipole moment can be induced in hydrogen collisionally. For the $n=2$ excitation values of D_z up to about $2|e|a_0$ have been observed (see in [29]). The magnitude and sign of D_z depend strongly on the collision system, the impact energy, and the kind of the excitation process (direct or charge exchange). From the point of view of the present investigations it is an interesting question of how large is the dipole moment induced in the collisional electron detachment of H^- . Another interesting question is what are the characteristics (intensity, shape) of the dipole-induced cusp in comparison with the cusp caused by the Coulomb interaction? In the present experiment we only proved the existence of the cusp, but the accuracy of the data

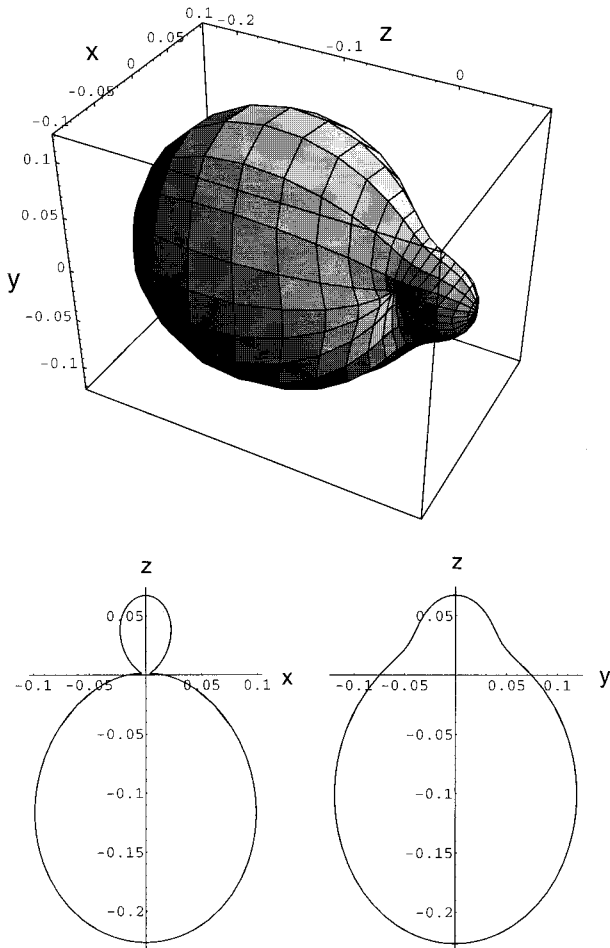

FIG. 6. An example for the $n=2$ excitation of hydrogen when the center-of-charge of the electron is shifted with respect to the proton position.

is not enough for a more detailed analysis. We mention here that to confirm the present findings, model calculations using the classical trajectory Monte Carlo method have been started [31]. In this model the projectile is an electric dipole consisting of a proton and an electron separated at a fixed distance of one atomic unit (the orientation of the dipole is also fixed). The investigated process is the cusp production in *target* ionization (i.e., the ECC process) by the electric dipole. It is hoped that, although the model is classical, the calculations will reflect more or less correctly the relative differences in the intensity and the shape of the cusp between the cases of the dipolar and Coulomb interaction.

The occurrence of the cusp due to dipolar interaction is a unique feature of the collisions involving *neutral hydrogen* as outgoing projectile. This is because the permanent electric dipole moment can only be induced in hydrogen due to the near degeneracy of the l -states belonging to the same principal quantum number. Consequently, no cusp is expected in the collisional single-electron detachment of He^- , or for any other negative ion. In accordance with the expectation, in a similar experiment no cusp was observed in the SEL spectrum measured in collisions of 200 keV He^- ions with He [32]. In this context we mention here the recent work of Lee *et al.* [33]. These authors observed similar resonance structure in the spectra of electrons detached from 100 keV Li^-

and B^- projectiles in collisions with He and Ar as the $(2s2p)^1P^o$ shape resonance of H^- in the present study. Although in the spectra the cusp also appeared, its origin was not clarified, since the measurements were carried out without coincidence condition. The measurement of SEL for Li^- and B^- impact in a coincidence experiment would be highly desirable. For these ions the resonance energies are relatively large (50 and 104 meV, respectively), therefore the resonance peaks do not mask the cusp so much as for He^- where the energy of the disturbing $(1s2p2p')^4P^e$ shape resonance is very small (≈ 11 meV [22,34]). Consequently, more reliable information on the threshold behavior of the SEL process is expected from the measurements with Li^- and B^- projectiles.

To clarify further the dipole-induced cusp in hydrogen, it would be important to measure the SEL spectrum in coincidence with the outgoing H^0 atoms as well as with the Lyman- α photons at the same impact energy and within the same experimental conditions. Comparing the results of the two coincidence measurements, one could determine the contributions of $\text{H}(2s)$ and other excited states to the cusp, and also the contribution of $\text{H}(1s)$ to SEL which appears as a smooth background in the spectrum taken in coincidence with H^0 . The role of the higher excitations could also be investigated in a direct way measuring the SEL spectrum in coincidence with photons of suitably selected energy.

Another interesting feature of the collisional electron detachment from H^- is the phenomenon of the so-called Gailitis-Damburg oscillations appearing in the SEL spectrum [35,6]. An indication for the existence of the oscillations has been reported by Penent *et al.* [9]. To prove the predicted weak structure convincingly, one has to provide a resolution of a few meV in the projectile frame. This can be achieved increasing further the angular resolution and lowering the projectile energy. The high-resolution measurement of SEL is desirable also from that point of view that on the basis of the present experiment we cannot exclude the contributions of other *unresolved* shape resonances to the cusp. For example, recently Bhatia and Ho [36] predicted a $^3D^o$ resonance lying above the $\text{H}(n=3)$ threshold by 1.5 meV.

IV. CONCLUSION

We have measured the energy spectra of electrons resulting from single and double electron detachment of 85 keV H^- ions in collisions with He atoms. The single and double electron loss channels were identified measuring the electrons in coincidence with the charge-state selected outgoing projectiles. With good energy and angular resolution we were able to separate the cusp from the lines of the $(2s2p)^1P^o$ shape resonance of H^- , appearing in the SEL spectrum. The result that the cusp exists in the SEL spectrum is in accordance with the theory of Liu and Starace [6], and it supports the finding of Penent *et al.*, [9] who also observed the cusp in SEL detecting the electrons in coincidence with the Lyman- α photons emitted by the outgoing excited H^0 atoms. The formation of the cusp in SEL can be explained as a result of dipolar interaction between the detached electron and the outgoing H^0 atom. An interesting finding of the present work is that the intensity of the cusp from the double-electron process, DEL, is larger than that of the cusp

from the single-electron process, SEL. This result is in accordance with the picture that the SEL cusp is induced by the weak dipolar interaction. The large asymmetry observed for the DEL cusp is probably due to the correlated motion of the two electrons in the Coulomb field of the proton.

Although the analysis of the obtained data indicates the importance of the dipole interaction in case of SEL and the electron correlation in DEL, these assumptions should be confirmed by quantitative theoretical calculations. From the side of the experiment the observation of very low energy structures in SEL, like the Gailitis-Damburg oscillations and shape resonances belonging to higher excitations of

H^0 , would be a further important step towards the better understanding of the structure and dynamics of the simplest negative ion, H^- .

ACKNOWLEDGMENTS

This work was supported by the Hungarian Scientific Research Foundation (OTKA, Grant Nos. 3011 and T016636) and the Hungarian-French S & T "Balaton" Program (Grant No. 8). The authors wish to express their thanks to P. A. Závodszy for providing the computer program by which the fitting of the data was carried out.

-
- [1] L. H. Andersen, J. P. Bangsgaard, and J. Sørensen, *Phys. Rev. Lett.* **57**, 1558 (1986).
- [2] M. M. Duncan and M. G. Menendez, *Phys. Rev. A* **39**, 1534 (1989).
- [3] F. Penent, J. P. Grouard, J. L. Montmagnon, and R. I. Hall, *J. Phys. B* **24**, 173 (1991).
- [4] E. P. Wigner, *Phys. Rev.* **73**, 1002 (1948).
- [5] A. Salin, *J. Phys. B* **2**, 631 (1969).
- [6] C. R. Liu and A. F. Starace, *Phys. Rev. Lett.* **62**, 407 (1989).
- [7] M. M. Duncan, M. G. Menendez, J. L. Hopkins, and C. R. Mauldin, *Phys. Rev. Lett.* **55**, 1983 (1985).
- [8] M. M. Duncan, M. G. Menendez, C. B. Mauldin, and J. L. Hopkins, *Phys. Rev. A* **34**, 4657 (1986).
- [9] F. Penent, J. P. Grouard, J. L. Montmagnon, and R. I. Hall, *J. Phys. B* **25**, 2831 (1992).
- [10] L. Sarkadi, J. Pálkás, Á. Kövér, D. Berényi, and T. Vajnai, *Phys. Rev. Lett.* **62**, 527 (1989).
- [11] D. Berényi, L. Sarkadi, L. Gulyás, Á. Kövér, Gy. Szabó, and J. Pálkás, *Acta Phys. Hungar.* **70**, 381 (1991).
- [12] P. A. Závodszy, L. Sarkadi, J. A. Tanis, D. Berényi, J. Pálkás, V. L. Plano, L. Gulyás, E. Takács, and L. Tóth, *Nucl. Instrum. Methods B* **79**, 67 (1993).
- [13] L. Víkor, P. A. Závodszy, L. Sarkadi, J. A. Tanis, M. Kuzel, A. Báder, J. Pálkás, E. Y. Kamber, D. Berényi, and K. O. Groeneveld, *J. Phys. B* **28**, 3915 (1995).
- [14] D. H. Jakubassa-Amundsen, *J. Phys. B* **22**, 3989 (1989).
- [15] L. Szótér, *Phys. Rev. Lett.* **64**, 2835 (1990).
- [16] R. O. Barrachina, *J. Phys. B* **23**, 2321 (1990).
- [17] Sh. D. Kunikeev and V. S. Senashenko, *Zh. Eksp. Teor. Fiz.* **102**, 826 (1992) [*Sov. Phys. JETP* **75**, 452 (1992)].
- [18] A. Salin (private communication).
- [19] Á. Kövér, L. Sarkadi, J. Pálkás, D. Berényi, Gy. Szabó, T. Vajnai, O. Heil, K. O. Groeneveld, J. Gibbons, and I. A. Sellin, *J. Phys. B* **22**, 1595 (1989).
- [20] L. Víkor, L. Sarkadi, K. Tőkési, D. Varga, F. Penent, and J. Pálkás, *Nucl. Instrum. Methods B* **114**, 164 (1996).
- [21] N. Stolterfoht, *Phys. Rep.* **146**, 315 (1987).
- [22] P. A. Závodszy, L. Sarkadi, L. Víkor, and J. Pálkás, *Phys. Rev. A* **50**, R899 (1994).
- [23] J. F. Williams, *J. Phys. B* **21**, 2107 (1988); H. C. Bryant, David A. Clark, Kenneth B. Butterfield, C. A. Frost, H. Sharifian, H. Tootoonchi, J. B. Donahue, P. A. M. Gram, M. E. Hamm, R. W. Hamm, J. C. Pratt, M. A. Yates, and W. W. Smith, *Phys. Rev. A* **27**, 2889 (1983).
- [24] D. Varga, Á. Kövér, L. Kövér, and L. Redler, *Nucl. Instrum. Methods A* **238**, 393 (1985); Á. Kövér, D. Varga, I. Cserny, E. Szmola, Gy. Móri, L. Gulyás, and K. Tőkési, *ibid.* **373**, 51 (1996).
- [25] A. Báder, L. Sarkadi, Gy. Hegyesi, L. Víkor, and J. Pálkás, *Meas. Sci. Technol.* **6**, 959 (1995).
- [26] J. Sørensen, L. H. Andersen, and L. B. Nielsen, *J. Phys. B* **21**, 847 (1988).
- [27] B. W. Shore, *Rev. Mod. Phys.* **39**, 439 (1967); V. V. Balashov, S. S. Lipovetski, and V. S. Senashenko, *Zh. Éksp. Teor. Fiz.* **63**, 1622 (1972) [*Sov. Phys. JETP* **36**, 858 (1973)].
- [28] W. Meckbach, I. B. Nemirovsky, and C. R. Garibotti, *Phys. Rev. A* **24**, 1793 (1981).
- [29] B. Siegmann, G. G. Tepehan, R. Hippler, H. Madeheim, H. Kleinpoppen, and H. O. Lutz, *Z. Phys. D* **30**, 223 (1994).
- [30] A. Jain, C. D. Lin, and W. Fritsch, *Phys. Rev. A* **36**, 2041 (1987).
- [31] K. Tőkési (private communication).
- [32] L. Víkor and L. Sarkadi (unpublished).
- [33] D. H. Lee, W. D. Brandon, D. Hanstorp, and D. J. Pegg, *Phys. Rev. A* **53**, R633 (1996).
- [34] J. R. Peterson, Z. K. Bae, and D. L. Huestis, *Phys. Rev. Lett.* **55**, 692 (1985).
- [35] M. Gailitis and R. Damburg, *Proc. Phys. Soc.* **82**, 192 (1963).
- [36] A. K. Bhatia and Y. K. Ho, *Phys. Rev. A* **50**, 4886 (1994).